



### FEATURES

- 2 selectable differential inputs
- 4.8 GHz operating frequency
- 75 fs rms broadband random jitter
- On-chip input terminations
- 3.3 V power supply

### APPLICATIONS

- Low jitter clock distribution
- Clock and data signal restoration
- Level translation
- Wireless communications
- Wired communications
- Medical and industrial imaging
- ATE and high performance instrumentation

### GENERAL DESCRIPTION

The ADCLK954 is an ultrafast clock fanout buffer fabricated on the Analog Devices, Inc., proprietary XFCB3 silicon germanium (SiGe) bipolar process. This device is designed for high speed applications requiring low jitter.

The device has two selectable differential inputs via the IN\_SEL control pin. Both inputs are equipped with center tapped, differential, 100 Ω on-chip termination resistors. The inputs accept dc-coupled LVPECL, CML, 3.3 V CMOS (single-ended), and ac-coupled 1.8 V CMOS, LVDS, and LVPECL inputs. A V\_REFX pin is available for biasing ac-coupled inputs.

The ADCLK954 features 12 full-swing emitter coupled logic (ECL) output drivers. For LVPECL (positive ECL) operation, bias V<sub>CC</sub> to the positive supply and V<sub>EE</sub> to ground. For ECL operation, bias V<sub>CC</sub> to ground and V<sub>EE</sub> to the negative supply.

The output stages are designed to directly drive 800 mV each side into 50 Ω terminated to V<sub>CC</sub> - 2 V for a total differential output swing of 1.6 V.

The ADCLK954 is available in a 40-lead LFCSP and specified for operation over the standard industrial temperature range of -40°C to +85°C.

### FUNCTIONAL BLOCK DIAGRAM

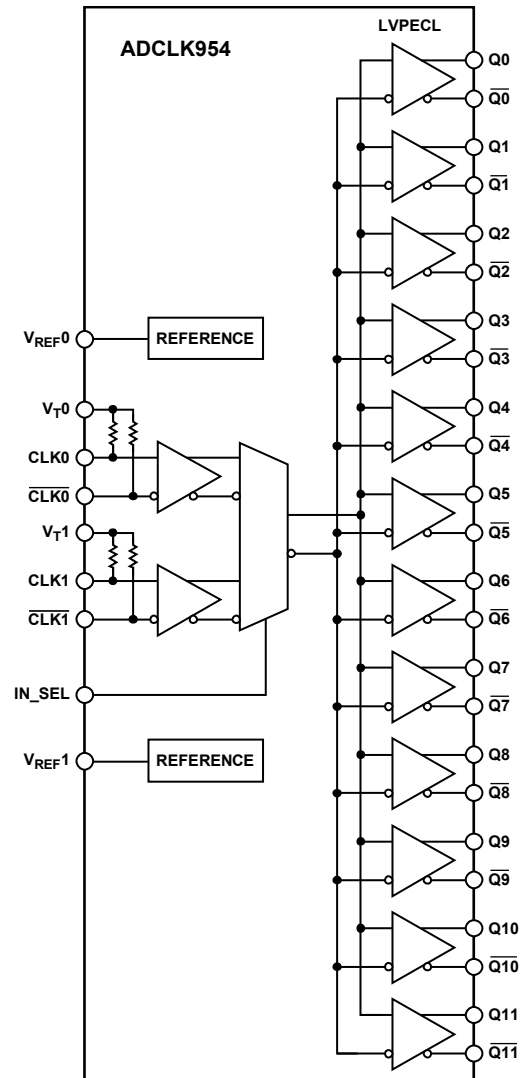

Figure 1.

07998-001

### Rev. B

Information furnished by Analog Devices is believed to be accurate and reliable. However, no responsibility is assumed by Analog Devices for its use, nor for any infringements of patents or other rights of third parties that may result from its use. Specifications subject to change without notice. No license is granted by implication or otherwise under any patent or patent rights of Analog Devices. Trademarks and registered trademarks are the property of their respective owners.

## TABLE OF CONTENTS

Features .....	1	Pin Configuration and Function Descriptions.....	6
Applications.....	1	Typical Performance Characteristics .....	7
General Description .....	1	Functional Description.....	9
Functional Block Diagram .....	1	Clock Inputs .....	9
Revision History .....	2	Clock Outputs.....	9
Specifications.....	3	Clock Input Select (IN_SEL) Settings.....	10
Electrical Characteristics .....	3	PCB Layout Considerations.....	10
Absolute Maximum Ratings.....	5	Input Termination Options.....	11
Determining Junction Temperature .....	5	Outline Dimensions .....	12
ESD Caution.....	5	Ordering Guide .....	12
Thermal Performance.....	5		

## REVISION HISTORY

### 6/10—Rev. A to Rev. B

Changed Output Voltage Differential Parameter to Output Voltage, Single Ended Parameter, Table 1 .....	3
Changes to Output Voltage, Single Ended Parameter, Table 1 ...	3

### 7/09—Rev. 0 to Rev. A

Changes to Table 1.....	3
Changes to Negative Supply Current, Table 4.....	4
Changes to Positive Supply Current, Table 4 .....	4
Changes to Figure 10.....	8

### 1/09—Revision 0: Initial Version

# SPECIFICATIONS

## ELECTRICAL CHARACTERISTICS

Typical (Typ column) values are given for  $V_{CC} - V_{EE} = 3.3\text{ V}$  and  $T_A = 25^\circ\text{C}$ , unless otherwise noted. Minimum (Min column) and maximum (Max column) values are given over the full  $V_{CC} - V_{EE} = 3.3\text{ V} \pm 10\%$  and  $T_A = -40^\circ\text{C}$  to  $+85^\circ\text{C}$  variation, unless otherwise noted.

**Table 1. Clock Inputs and Outputs**

Parameter	Symbol	Min	Typ	Max	Unit	Test Conditions/Comments
DC INPUT CHARACTERISTICS						
Input Common-Mode Voltage	$V_{ICM}$	$V_{EE} + 1.5$		$V_{CC} - 0.1$	V	$\pm 1.7\text{ V}$ between input pins
Input Differential Range	$V_{ID}$	0.4		3.4	V p-p	
Input Capacitance	$C_{IN}$		0.4		pF	
Input Resistance						Open $V_{IX}$
Single-Ended Mode			50		$\Omega$	
Differential Mode			100		$\Omega$	
Common Mode			50		k $\Omega$	
Input Bias Current			20		$\mu\text{A}$	
Hysteresis			10		mV	
DC OUTPUT CHARACTERISTICS						
Output Voltage High Level	$V_{OH}$	$V_{CC} - 1.26$		$V_{CC} - 0.76$	V	$50\ \Omega$ to $(V_{CC} - 2.0\text{ V})$
Output Voltage Low Level	$V_{OL}$	$V_{CC} - 1.99$		$V_{CC} - 1.54$	V	$50\ \Omega$ to $(V_{CC} - 2.0\text{ V})$
Output Voltage, Single Ended	$V_O$	610		960	mV	$V_{OH} - V_{OL}$ , output static
Reference Voltage	$V_{REF}$					
Output Voltage			$(V_{CC} + 1)/2$		V	$-500\ \mu\text{A}$ to $+500\ \mu\text{A}$
Output Resistance			235		$\Omega$	

**Table 2. Timing Characteristics**

Parameter	Symbol	Min	Typ	Max	Unit	Test Conditions/Comments
AC PERFORMANCE						
Maximum Output Frequency		4.5	4.8		GHz	See Figure 4 for differential output voltage vs. frequency, $> 0.8\text{ V}$ differential output swing
Output Rise Time	$t_R$	40	75	90	ps	20% to 80% measured differentially
Output Fall Time	$t_F$	40	75	90	ps	
Propagation Delay	$t_{PD}$	175	210	245	ps	$V_{ICM} = 2\text{ V}$ , $V_{ID} = 1.6\text{ V p-p}$
Temperature Coefficient			50		fs/ $^\circ\text{C}$	
Output-to-Output Skew <sup>1</sup>			9	25	ps	
Part-to-Part Skew				45	ps	$V_{ID} = 1.6\text{ V p-p}$
Additive Time Jitter						
Integrated Random Jitter			28		fs rms	BW = 12 kHz – 20 MHz, CLK = 1 GHz
Broadband Random Jitter <sup>2</sup>			75		fs rms	$V_{ID} = 1.6\text{ V p-p}$ , 8 V/ns, $V_{ICM} = 2\text{ V}$
Crosstalk-Induced Jitter <sup>3</sup>			90		fs rms	
CLOCK OUTPUT PHASE NOISE						
Absolute Phase Noise						Input slew rate $> 1\text{ V/ns}$ (see Figure 11, the phase noise plot, for more details)
$f_{IN} = 1\text{ GHz}$			-119		dBc/Hz	@100 Hz offset
			-134		dBc/Hz	@1 kHz offset
			-145		dBc/Hz	@10 kHz offset
			-150		dBc/Hz	@100 kHz offset
			-150		dBc/Hz	$> 1\text{ MHz}$ offset

<sup>1</sup> The output skew is the difference between any two similar delay paths while operating at the same voltage and temperature.

<sup>2</sup> Measured at the rising edge of the clock signal; calculated using the SNR of the ADC method.

<sup>3</sup> This is the amount of added jitter measured at the output while two related, asynchronous, differential frequencies are applied to the inputs.

# ADCLK954

Table 3. Input Select Control Pin

Parameter	Symbol	Min	Typ	Max	Unit
Logic 1 Voltage	$V_{IH}$	$V_{CC} - 0.4$		$V_{CC}$	V
Logic 0 Voltage	$V_{IL}$	$V_{EE}$		1.0	V
Logic 1 Current	$I_{IH}$			100	$\mu A$
Logic 0 Current	$I_{IL}$			0.6	mA
Capacitance			2		pF

Table 4. Power

Parameter	Symbol	Min	Typ	Max	Unit	Test Conditions/Comments
POWER SUPPLY						
Supply Voltage Requirement	$V_{CC} - V_{EE}$	2.97		3.63	V	3.3 V + 10%
Power Supply Current						Static
Negative Supply Current	$I_{VEE}$		118	160	mA	$V_{CC} - V_{EE} = 3.3 V \pm 10\%$
Positive Supply Current	$I_{VCC}$		406	460	mA	$V_{CC} - V_{EE} = 3.3 V \pm 10\%$
Power Supply Rejection <sup>1</sup>	$PSR_{VCC}$		<3		ps/V	$V_{CC} - V_{EE} = 3.3 V \pm 10\%$
Output Swing Supply Rejection <sup>2</sup>	$PSR_{VCC}$		28		dB	$V_{CC} - V_{EE} = 3.3 V \pm 10\%$

<sup>1</sup> Change in  $t_{PD}$  per change in  $V_{CC}$ .

<sup>2</sup> Change in output swing per change in  $V_{CC}$ .

## ABSOLUTE MAXIMUM RATINGS

Table 5.

Parameter	Rating
Supply Voltage $V_{CC} - V_{EE}$	6.0 V
Input Voltage CLK0, CLK1, $\overline{\text{CLK0}}$ , $\overline{\text{CLK1}}$ , IN_SEL	$V_{EE} - 0.5 \text{ V}$ to $V_{CC} + 0.5 \text{ V}$
CLK0, CLK1, $\overline{\text{CLK0}}$ , $\overline{\text{CLK1}}$ to $V_{TX}$ Pin (CML, LVPECL Termination)	$\pm 40 \text{ mA}$
CLK0, CLK1 to $\overline{\text{CLK0}}$ , $\overline{\text{CLK1}}$	$\pm 1.8 \text{ V}$
Input Termination, $V_{TX}$ to CLK0, CLK1, $\overline{\text{CLK0}}$ , and $\overline{\text{CLK1}}$	$\pm 2 \text{ V}$
Maximum Voltage on Output Pins	$V_{CC} + 0.5 \text{ V}$
Maximum Output Current	35 mA
Voltage Reference ( $V_{REFX}$ )	$V_{CC}$ to $V_{EE}$
Operating Temperature Range	
Ambient	$-40^{\circ}\text{C}$ to $+85^{\circ}\text{C}$
Junction	$150^{\circ}\text{C}$
Storage Temperature Range	$-65^{\circ}\text{C}$ to $+150^{\circ}\text{C}$

Stresses above those listed under Absolute Maximum Ratings may cause permanent damage to the device. This is a stress rating only; functional operation of the device at these or any other conditions above those indicated in the operational section of this specification is not implied. Exposure to absolute maximum rating conditions for extended periods may affect device reliability.

## THERMAL PERFORMANCE

Table 6.

Parameter	Symbol	Description	Value <sup>1</sup>	Unit
Junction-to-Ambient Thermal Resistance	$\theta_{JA}$			
Still Air		Per JEDEC JESD51-2	46.1	$^{\circ}\text{C}/\text{W}$
0.0 m/sec Air Flow				
Moving Air	$\theta_{JMA}$	Per JEDEC JESD51-6	40.3	$^{\circ}\text{C}/\text{W}$
1.0 m/sec Air Flow			36.2	$^{\circ}\text{C}/\text{W}$
2.5 m/sec Air Flow				
Junction-to-Board Thermal Resistance	$\theta_{JB}$			
Moving Air		Per JEDEC JESD51-8	28.7	$^{\circ}\text{C}/\text{W}$
1.0 m/sec Air Flow				
Junction-to-Case Thermal Resistance	$\theta_{JC}$			
Moving Air		Per MIL-STD 883, Method 1012.1	8.3	$^{\circ}\text{C}/\text{W}$
Die-to-Heat Sink				
Junction-to-Top-of-Package Characterization Parameter	$\Psi_{JT}$			
Still Air		Per JEDEC JESD51-2	0.6	$^{\circ}\text{C}/\text{W}$
0 m/sec Air Flow				

<sup>1</sup> Results are from simulations. The PCB is a JEDEC multilayer type. Thermal performance for actual applications requires careful inspection of the conditions in the application to determine if they are similar to those assumed in these calculations.

## DETERMINING JUNCTION TEMPERATURE

To determine the junction temperature on the application printed circuit board (PCB), use the following equation:

$$T_J = T_{CASE} + (\Psi_{JT} \times P_D)$$

where:

$T_J$  is the junction temperature ( $^{\circ}\text{C}$ ).

$T_{CASE}$  is the case temperature ( $^{\circ}\text{C}$ ) measured by the customer at the top center of the package.

$\Psi_{JT}$  is from Table 6.

$P_D$  is the power dissipation.

Values of  $\theta_{JA}$  are provided for package comparison and PCB design considerations.  $\theta_{JA}$  can be used for a first-order approximation of  $T_J$  by the equation

$$T_J = T_A + (\theta_{JA} \times P_D)$$

where  $T_A$  is the ambient temperature ( $^{\circ}\text{C}$ ).

Values of  $\theta_{JB}$  are provided in Table 6 for package comparison and PCB design considerations.

## ESD CAUTION



**ESD (electrostatic discharge) sensitive device.** Charged devices and circuit boards can discharge without detection. Although this product features patented or proprietary protection circuitry, damage may occur on devices subjected to high energy ESD. Therefore, proper ESD precautions should be taken to avoid performance degradation or loss of functionality.

# ADCLK954

## PIN CONFIGURATION AND FUNCTION DESCRIPTIONS

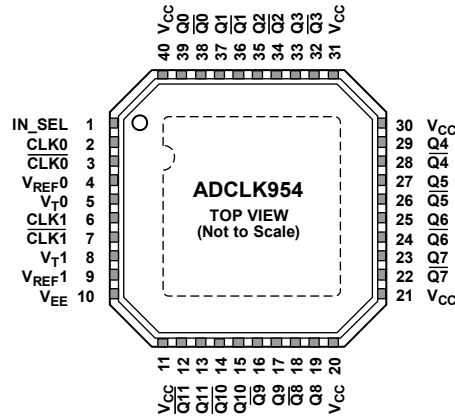

NOTES  
1. EPAD MUST BE SOLDERED TO V<sub>EE</sub> POWER PLANE.

Figure 2. Pin Configuration

Table 7. Pin Function Descriptions

Pin No.	Mnemonic	Description
1	IN_SEL	Input Select. Logic 0 selects CLK0 and $\overline{\text{CLK0}}$ inputs. Logic 1 selects CLK1 and $\overline{\text{CLK1}}$ inputs.
2	CLK0	Differential Input (Positive) 0.
3	$\overline{\text{CLK0}}$	Differential Input (Negative) 0.
4	V <sub>REF0</sub>	Reference Voltage. Reference voltage for biasing ac-coupled CLK0 and $\overline{\text{CLK0}}$ inputs.
5	V <sub>T0</sub>	Center Tap. Center tap of a 100 $\Omega$ input resistor for CLK0 and $\overline{\text{CLK0}}$ inputs.
6	CLK1	Differential Input (Positive) 1.
7	$\overline{\text{CLK1}}$	Differential Input (Negative) 1.
8	V <sub>T1</sub>	Center Tap. Center tap of a 100 $\Omega$ input resistor for CLK1 and $\overline{\text{CLK1}}$ inputs.
9	V <sub>REF1</sub>	Reference Voltage. Reference voltage for biasing ac-coupled CLK1 and $\overline{\text{CLK1}}$ inputs.
10	V <sub>EE</sub>	Negative Supply Pin.
11, 20, 21, 30, 31, 40	V <sub>CC</sub>	Positive Supply Pin.
12, 13	$\overline{\text{Q11}}$ , Q11	Differential LVPECL Outputs.
14, 15	$\overline{\text{Q10}}$ , Q10	Differential LVPECL Outputs.
16, 17	$\overline{\text{Q9}}$ , Q9	Differential LVPECL Outputs.
18, 19	$\overline{\text{Q8}}$ , Q8	Differential LVPECL Outputs.
22, 23	$\overline{\text{Q7}}$ , Q7	Differential LVPECL Outputs.
24, 25	$\overline{\text{Q6}}$ , Q6	Differential LVPECL Outputs.
26, 27	$\overline{\text{Q5}}$ , Q5	Differential LVPECL Outputs.
28, 29	$\overline{\text{Q4}}$ , Q4	Differential LVPECL Outputs.
32, 33	$\overline{\text{Q3}}$ , Q3	Differential LVPECL Outputs.
34, 35	$\overline{\text{Q2}}$ , Q2	Differential LVPECL Outputs.
36, 37	$\overline{\text{Q1}}$ , Q1	Differential LVPECL Outputs.
38, 39	$\overline{\text{Q0}}$ , Q0	Differential LVPECL Outputs.
	EPAD	Exposed pad (EPAD) must be connected to V <sub>EE</sub> .

# TYPICAL PERFORMANCE CHARACTERISTICS

$V_{CC} = 3.3\text{ V}$ ,  $V_{EE} = 0.0\text{ V}$ ,  $V_{ICM} = V_{REF}$ ,  $T_A = 25^\circ\text{C}$ , clock outputs terminated at  $50\ \Omega$  to  $V_{CC} - 2\text{ V}$ , unless otherwise noted.

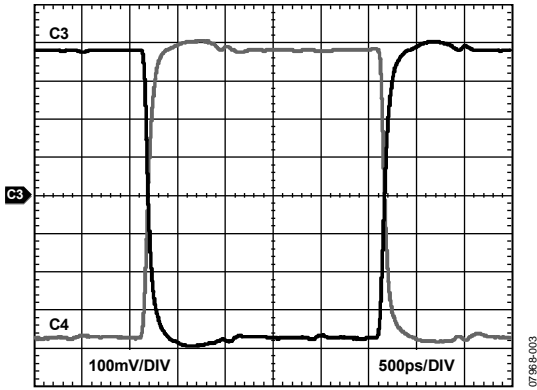

Figure 3. LVPECL Output Waveform @ 200 MHz

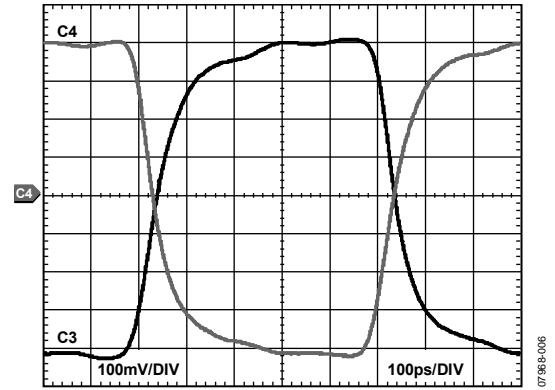

Figure 6. LVPECL Output Waveform @ 1000 MHz

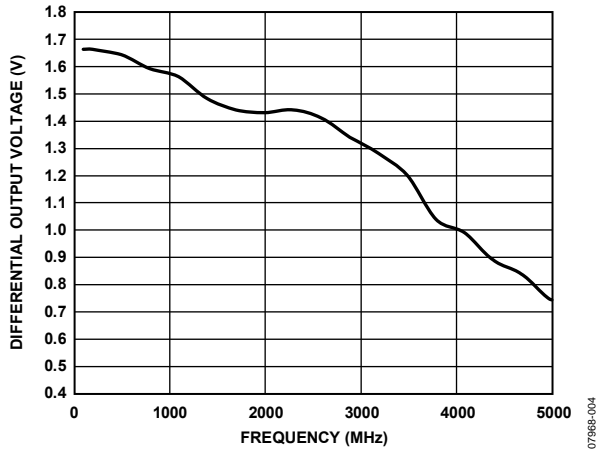

Figure 4. Differential Output Voltage vs. Frequency,  $V_{ID} > 1.1\text{ V p-p}$

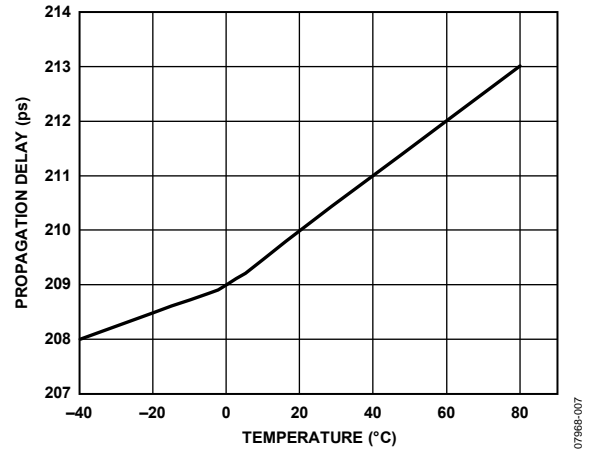

Figure 7. Propagation Delay vs. Temperature,  $V_{ID} = 1.6\text{ V p-p}$

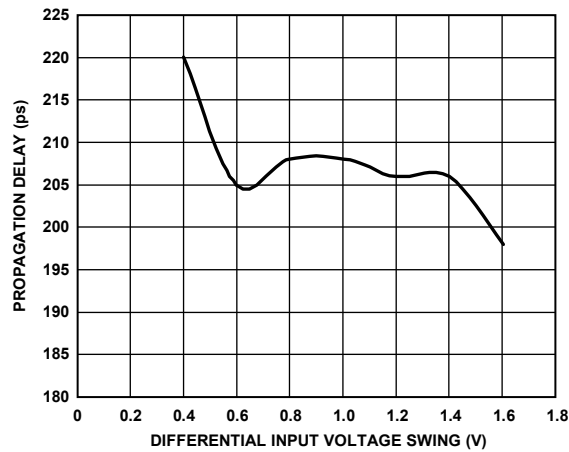

Figure 5. Propagation Delay vs. Differential Input Voltage

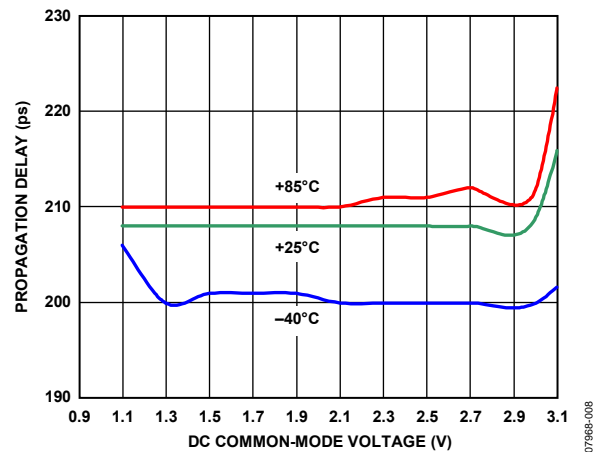

Figure 8. Propagation Delay vs. DC Common-Mode Voltage vs. Temperature, Input Slew Rate  $> 25\text{ V/ns}$

# ADCLK954

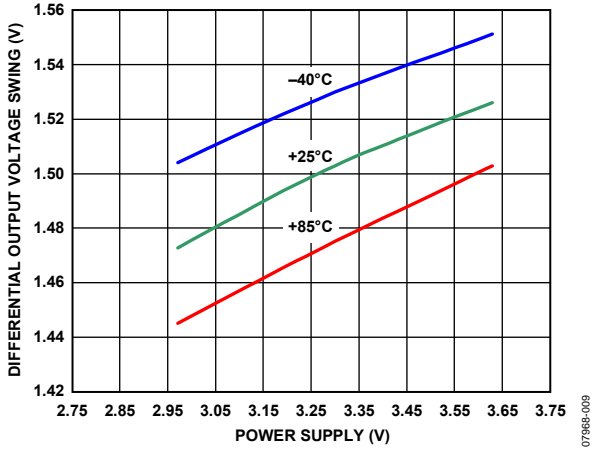

Figure 9. Differential Output Voltage Swing vs. Power Supply Voltage vs. Temperature,  $V_{ID} = 1.6$  V p-p

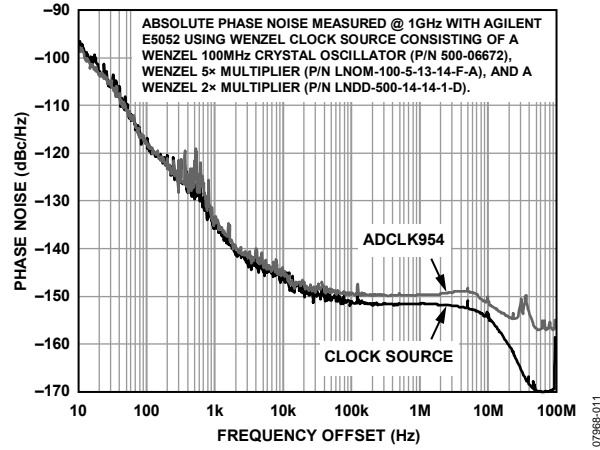

Figure 11. Absolute Phase Noise Measured @1 GHz

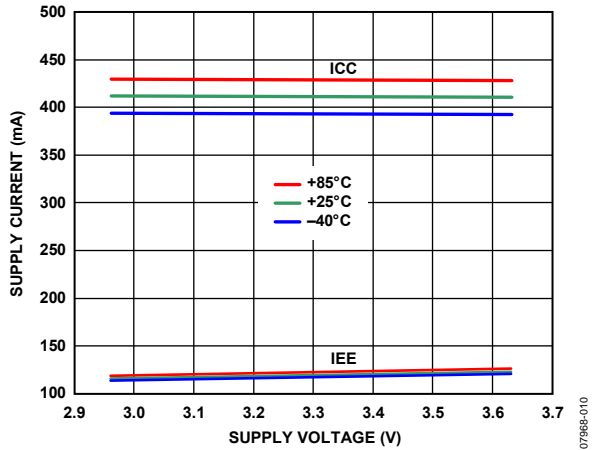

Figure 10. Power Supply Current vs. Power Supply Voltage vs. Temperature, All Outputs Loaded ( $50 \Omega$  to  $V_{CC} - 2$  V)

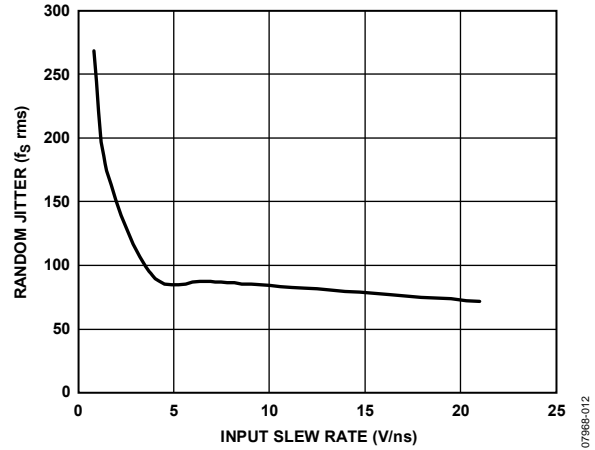

Figure 12. RMS Random Jitter vs. Input Slew Rate,  $V_{ID}$  Method



## FUNCTIONAL DESCRIPTION

### CLOCK INPUTS

The ADCLK954 accepts a differential clock input from one of two inputs and distributes the selected clock to all 12 LVPECL outputs. The maximum specified frequency is the point at which the output voltage swing is 50% of the standard LVPECL swing (see Figure 4). See the functional block diagram (Figure 1) and the General Description section for more clock input details. See Figure 19 through Figure 22 for various clock input termination schemes.

Output jitter performance is degraded by an input slew rate below 4 V/ns, as shown in Figure 12. The ADCLK954 is specifically designed to minimize added random jitter over a wide input slew rate range. Whenever possible, clamp excessively large input signals with fast Schottky diodes because attenuators reduce the slew rate. Input signal runs of more than a few centimeters should be over low loss dielectrics or cables with good high frequency characteristics.

### CLOCK OUTPUTS

The specified performance necessitates using proper transmission line terminations. The LVPECL outputs of the ADCLK954 are designed to directly drive 800 mV into a 50 Ω cable or into microstrip/stripline transmission lines terminated with 50 Ω referenced to  $V_{CC} - 2V$ , as shown in Figure 14. The LVPECL output stage is shown in Figure 13. The outputs are designed for best transmission line matching. If high speed signals must be routed more than a centimeter, either the microstrip or the stripline technique is required to ensure proper transition times and to prevent excessive output ringing and pulse width dependent propagation delay dispersion.

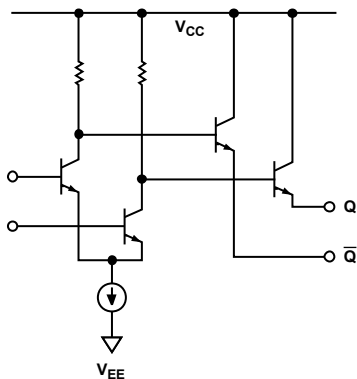

Figure 13. Simplified Schematic Diagram of the LVPECL Output Stage

Figure 14 through Figure 17 depict various LVPECL output termination schemes. When dc-coupled,  $V_s$  of the receiving buffer should match the  $V_{S\_DRV}$ .

Thevenin-equivalent termination uses a resistor network to provide 50 Ω termination to a dc voltage that is below  $V_{OL}$  of the LVPECL driver. In this case,  $V_{S\_DRV}$  on the ADCLK954 should equal  $V_s$  of the receiving buffer. Although the resistor combination shown (in Figure 15) results in a dc bias point of  $V_{S\_DRV} - 2V$ , the actual common-mode voltage is  $V_{S\_DRV} - 1.3V$  because there is additional current flowing from the ADCLK954 LVPECL driver through the pull-down resistor.

LVPECL Y-termination is an elegant termination scheme that uses the fewest components and offers both odd- and even-mode impedance matching. Even-mode impedance matching is an important consideration for closely coupled transmission lines at high frequencies. Its main drawback is that it offers limited flexibility for varying the drive strength of the emitter follower LVPECL driver. This can be an important consideration when driving long trace lengths, but is usually not an issue.

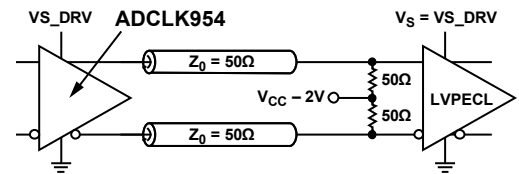

Figure 14. DC-Coupled, 3.3 V LVPECL

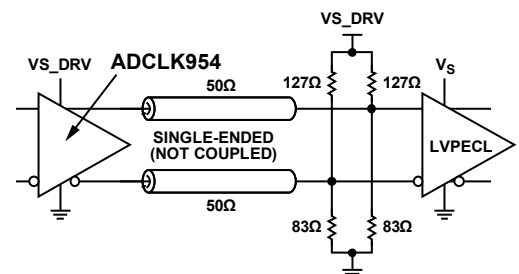

Figure 15. DC-Coupled, 3.3 V LVPECL Far-End Thevenin Termination

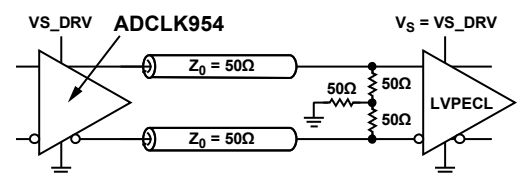

Figure 16. DC-Coupled, 3.3 V LVPECL Y-Termination

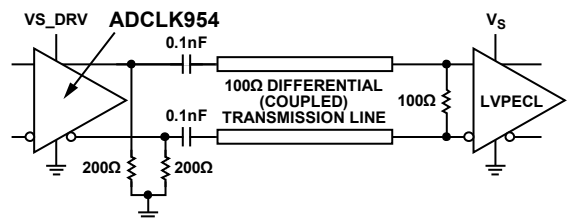

Figure 17. AC-Coupled, LVPECL with Parallel Transmission Line

# ADCLK954

## CLOCK INPUT SELECT (IN\_SEL) SETTINGS

A Logic 0 on the IN\_SEL pin selects the Input CLK0 and Input CLK0. A Logic 1 on the IN\_SEL pin selects Input CLK1 and Input CLK1.

## PCB LAYOUT CONSIDERATIONS

The ADCLK954 buffer is designed for very high speed applications. Consequently, high speed design techniques must be used to achieve the specified performance. It is critically important to use low impedance supply planes for both the negative supply ( $V_{EE}$ ) and the positive supply ( $V_{CC}$ ) planes as part of a multilayer board. Providing the lowest inductance return path for switching currents ensures the best possible performance in the target application.

The following references to GND plane assume that the  $V_{EE}$  power plane is grounded for LVPECL operation. Note that for ECL operation, the  $V_{CC}$  power plane becomes the ground plane.

It is also important to adequately bypass the input and output supplies. Place a 1  $\mu$ F electrolytic bypass capacitor within several inches of each  $V_{CC}$  power supply pin to the GND plane. In addition, place multiple high quality 0.001  $\mu$ F bypass capacitors as close as possible to each of the  $V_{CC}$  supply pins and connect the capacitors to the GND plane with redundant vias. Carefully select high frequency bypass capacitors for minimum inductance and ESR. To improve the effectiveness of the bypass at high frequencies, minimize parasitic layout inductance. Also, avoid discontinuities along input and output transmission lines that can affect jitter performance.

In a 50  $\Omega$  environment, input and output matching have a significant impact on performance. The buffer provides internal 50  $\Omega$  termination resistors for both CLKx and CLKx inputs. Normally, the return side is connected to the reference pin that is provided. Carefully bypass the termination potential using ceramic capacitors to prevent undesired aberrations on the input signal due to parasitic inductance in the termination return path. If the inputs are dc-coupled to a source, take care to ensure that the pins are within the rated input differential and common-mode ranges.

If the return is floated, the device exhibits a 100  $\Omega$  cross termination, but the source must then control the common-mode voltage and supply the input bias currents.

There are ESD/clamp diodes between the input pins to prevent the application from developing excessive offsets to the input transistors. ESD diodes are not optimized for best ac performance. When a clamp is required, it is recommended that appropriate external diodes be used.

### Exposed Metal Paddle

The exposed metal paddle on the ADCLK954 package is both an electrical connection and a thermal enhancement. For the device to function properly, the paddle must be properly attached to the  $V_{EE}$  power plane.

When properly mounted, the ADCLK954 also dissipates heat through its exposed paddle. The PCB acts as a heat sink for the ADCLK954. The PCB attachment must provide a good thermal path to a larger heat dissipation area. This requires a grid of vias from the top layer down to the  $V_{EE}$  power plane (see Figure 18). The ADCLK954 evaluation board (ADCLK954/PCBZ) provides an example of how to attach the part to the PCB.

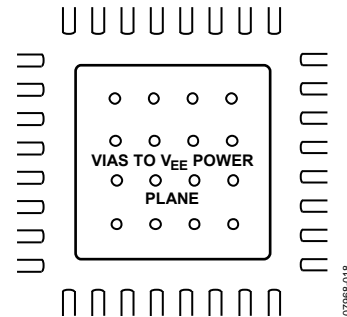
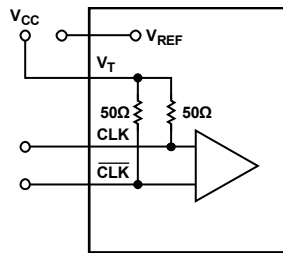

Figure 18. PCB Land for Attaching Exposed Paddle

INPUT TERMINATION OPTIONS



CONNECT  $V_T$  TO  $V_{CC}$ .  
 Figure 19. Interfacing to CML Inputs

07988-019

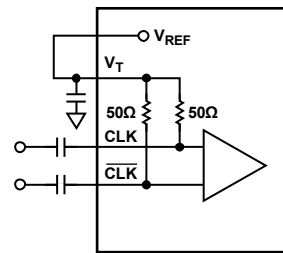

CONNECT  $V_T$  TO  $V_{REF}$ .  
 Figure 21. AC Coupling Differential Signals Inputs, Such As LVDS

07988-021

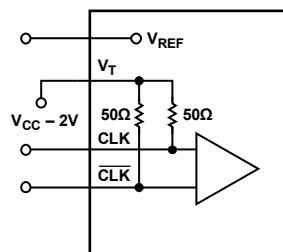

CONNECT  $V_T$  TO  $V_{CC} - 2V$ .  
 Figure 20. Interfacing to PECL Inputs

07988-020

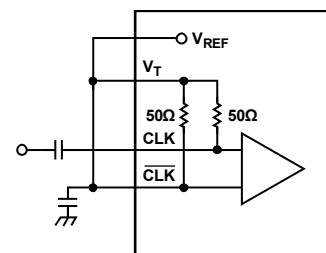

CONNECT  $V_T$ ,  $V_{REF}$ , AND  $\overline{CLK}$ . PLACE A BYPASS CAPACITOR FROM  $V_T$  TO GROUND. ALTERNATIVELY,  $V_T$ ,  $V_{REF}$ , AND  $\overline{CLK}$  CAN BE CONNECTED, GIVING A CLEANER LAYOUT AND A 180° PHASE SHIFT.

Figure 22. Interfacing to AC-Coupled Single-Ended Inputs

07988-022

# ADCLK954

## OUTLINE DIMENSIONS

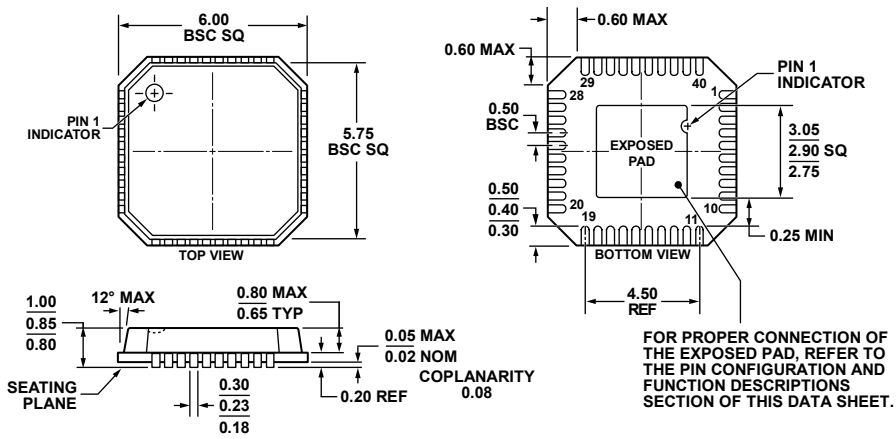

COMPLIANT TO JEDEC STANDARDS MO-220-VJJD-2  
 Figure 23. 40-Lead Lead Frame Chip Scale Package [LFSCP\_VQ]  
 6 mm × 6 mm Body, Very Thin Quad  
 (CP-40-8)  
 Dimensions shown in millimeters

082708-A

## ORDERING GUIDE

Model <sup>1</sup>	Temperature Range	Package Description	Package Option
ADCLK954BCPZ	-40°C to +85°C	40-Lead LFCSP_VQ	CP-40-8
ADCLK954BCPZ-REEL7	-40°C to +85°C	40-Lead LFCSP_VQ	CP-40-8
ADCLK954/PCBZ		Evaluation Board	

<sup>1</sup> Z = RoHS Compliant Part.